

■ **Features**

- Wall Plug Fixed Type
- Interchangeable Type
- Desktop type
- Energy efficiency: Level VI
- Load Regulation: +/-5%
- Surge: Over 1KV
- No Load power consumption < 0.1w
- Protections: OCP/OVP/OTP/SCP
- Warranty: 2 years

■ **Applications**

- Telecommunication electronic devices
- Consumer electronic devices
- Electrical home appliances
- LED lights or devices
- Industrial equipment
- Office Equipment



Safety certification: EN62368: UL/CB/CE/GS/UKCA/EMC/LVD/SAA/KC/FCC/PSE/CCC

EN61558: CE/GS/CB/UKCA/FCC/LVD/SAA/ETL 1310



■ **Model Encoding:**

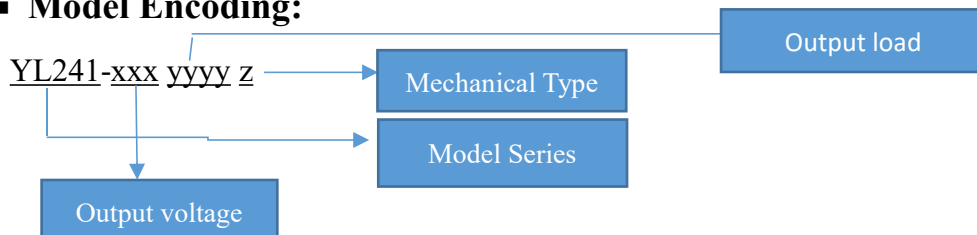

■ **Specification**

Power supply model number	YL241-XXXXYYYZ	
Output	DC voltage	5V - 30V
	Rated Current	MAX 3.7A
	Current Range	0-3.7A
	Max. Power	24W
	Ripple & Noise	200mVp-p Max
	Voltage Tolerance	+/- 5%
Input	Voltage Range	100-240V AC 50/60Hz
Safety Standard	IEC 62368-1B / IEC 61558-2-16E / ETL 1310	
Safety Certification	EN62368:UL/CB/CE/GS/UKCA/EMC/LVD/SAA/RCM/KC/FCC/PSE/CCC	
	EN61558:CE/GS/CB/UKCA/FCC/LVD/SAA/RCM/ETL1310	
Operating temperature	0-40 °C	
Storage temperature	-20+60 °C	
Hi-pot test	Primary To Secondary: 3000VAC 10mA 1 minute	
Burn-in test	80% load, 40 ± 5°C for 4 hours	
Length of DC cord	Optional	
DC plug	Optional	
RoHS/Reach	Yes	
Package	White box or plastic bag with outer carton	
AC Fixed PLUG (Interchangeable Plug)	UL/CE/UK/PSE/KC/SAA/CCC or More	
Desktop Type	Available	
Efficiency Level	VI	
load Regulation	+/-5%	
Surge	Over 1 KV	
No Load power consumption	< 0.1w	
Protections	OCP/OVP/OTP/SCP	
Warranty	2 years	

■ Mechanics

■ Wall Plug Fixed Type

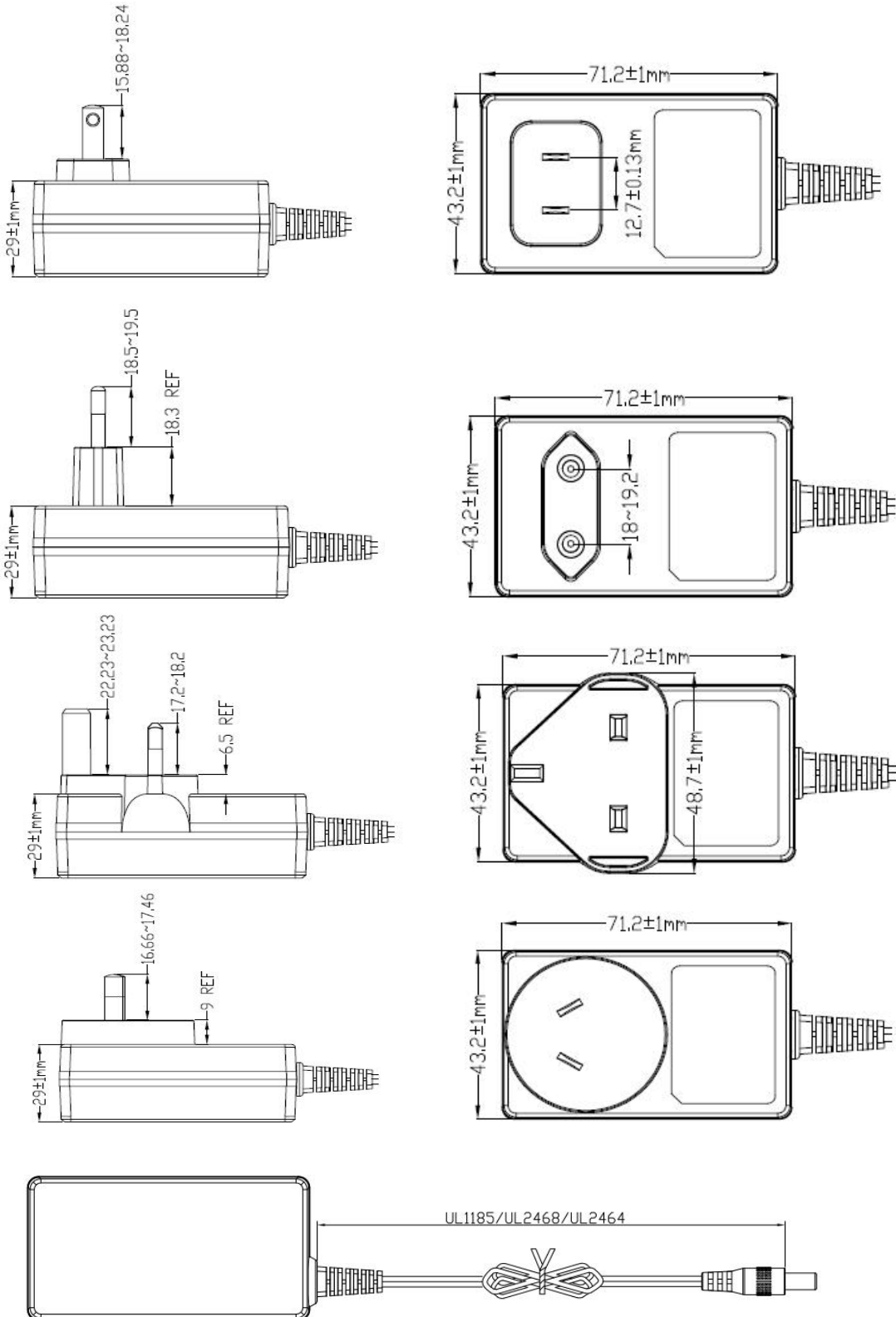



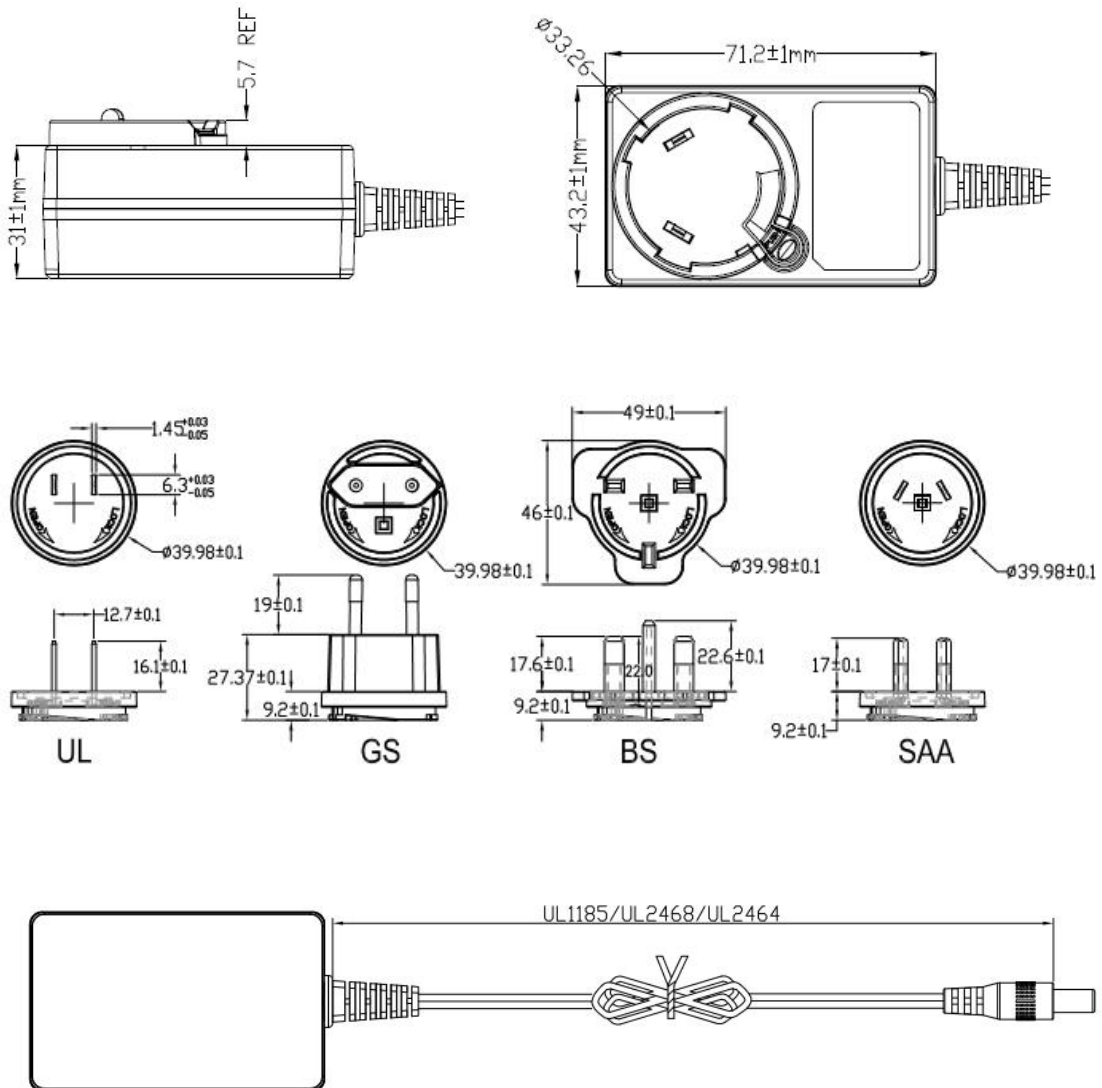

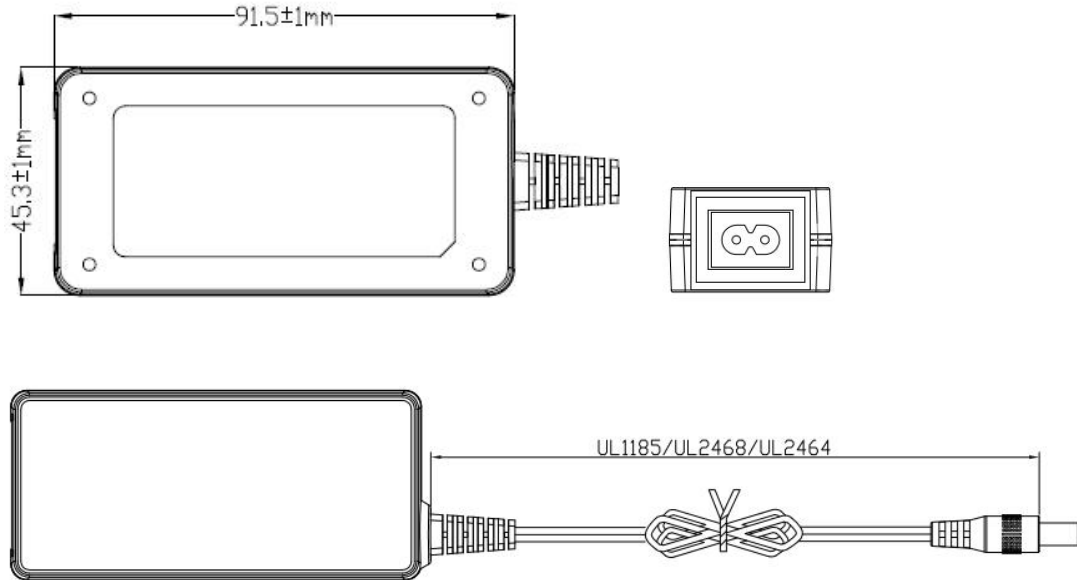

■ Interchangeable Type



■ Desktop Type

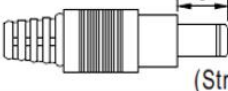
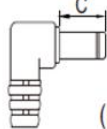

■ Optional DC plug:(Available in customized cable)

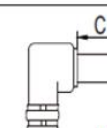
Tuning Fork Style		A	B	C		
		OD	ID	L		
 	 <p>(Straight)</p>	5.5	2.5	9-12MM		
		5.5	2.1	9-12MM		
		4.75	1.7	9-12MM		
		4.0	1.7	9-12MM		
		3.5	1.35	9-12MM		
		2.35	0.7	9-12MM		
		5.5	2.5	9-12MM		
	 <p>(Right-angled)</p>	5.5	2.1	9-12MM		
		4.75	1.7	9-12MM		
		4.0	1.7	9-12MM		
		3.5	1.35	9-12MM		
		2.35	0.7	9-12MM		
Barrel Style		A	B	C		
		OD	ID	L		
 	 <p>(Straight)</p>	5.5	2.5	9-12MM		
		5.5	2.1	9-12MM		
		4.75	1.7	9-12MM		
		4.0	1.7	9-12MM		
		3.5	1.35	9-12MM		
		2.35	0.7	9-12MM		
	 <p>(Right-angled)</p>	5.5	2.5	9-12MM		
		5.5	2.1	9-12MM		
		4.75	1.7	9-12MM		
		4.0	1.7	9-12MM		
		3.5	1.35	9-12MM		
		2.35	0.7	9-12MM		